

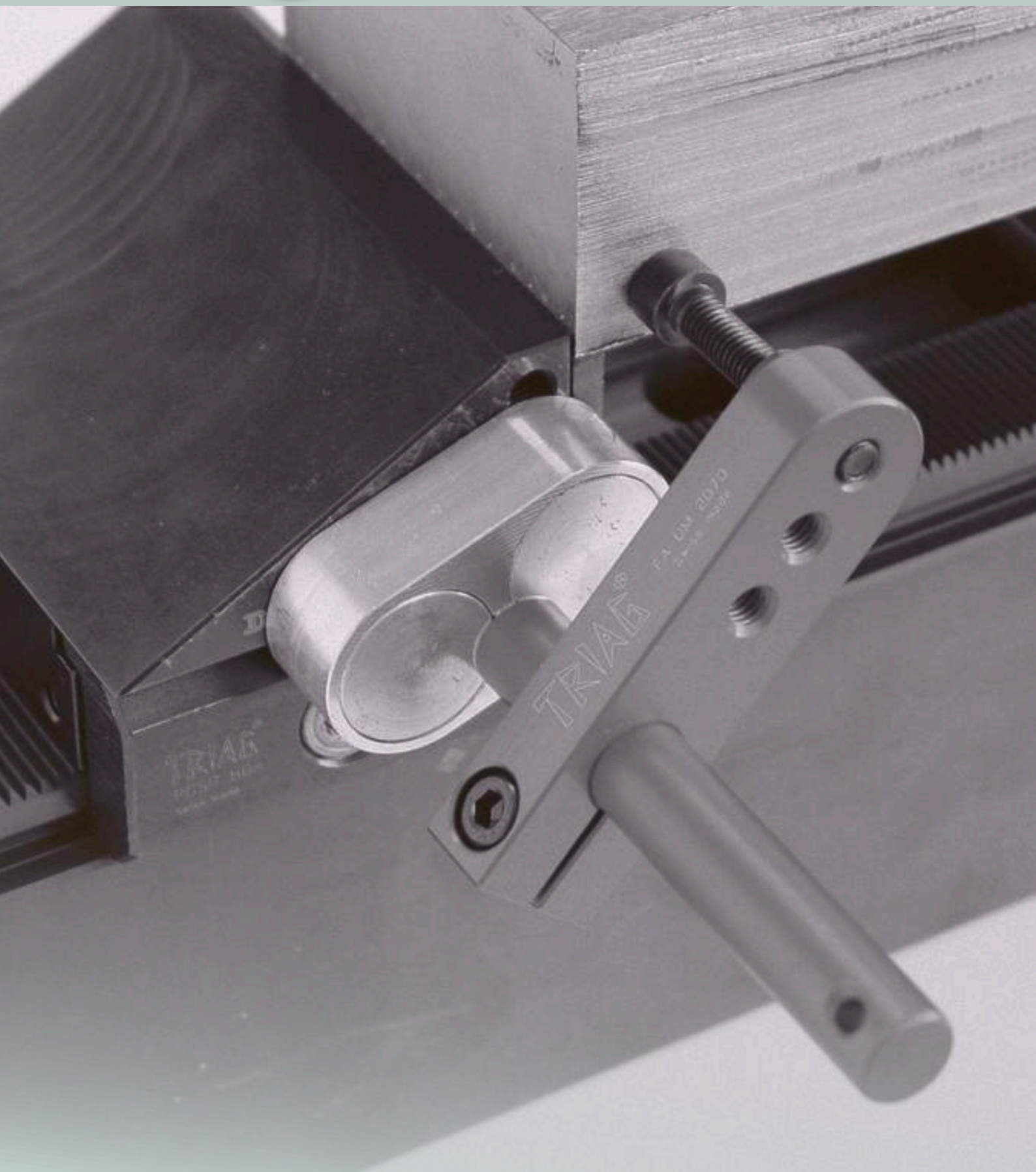

# Zubehör Accessories



Einstellmasstab | *Measuring device* ..... 335



Magnetanschlag | *Magnetic milling buffer* ..... 336

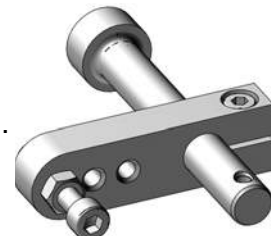

Fräsanschlag / Hartmetalldruckstück | *Milling buffer / Carbide gripper* ..... 337

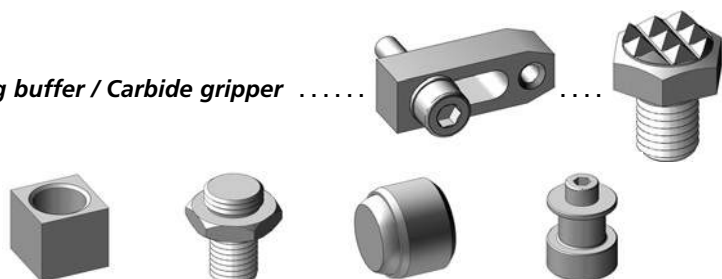

Stopfen / Spanschrauben / Passschrauben / T-Nuten Steine  
*Plug / Clamping screw / Fitting screw / T-slot nuts* ..... 338

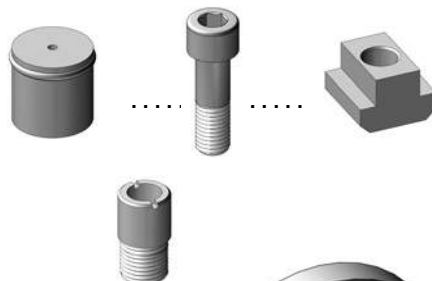

Triag Bitburr / Magnethalter / Pneumatikschrauber Set  
*Magnetic holder / Pneumatic screwdrivers set* ..... 339

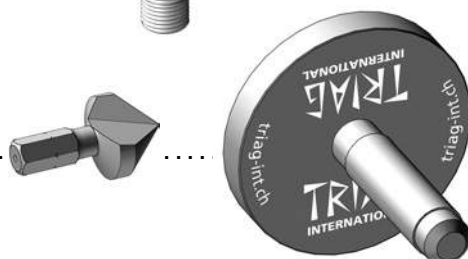

Drehmomentschlüssel / Spanschlüssel / Messingdrahtbürste  
*Torque wrenches / Clamping wrench / Brass wire brush* ..... 340

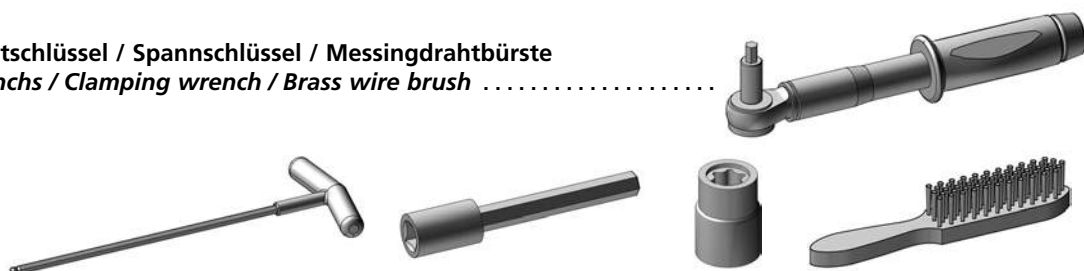

### Masstab mit Magnetleiste Scale with magnet profile

#### PCMAS800ML

- ① 1x PCMAS800ML
  - ② 2x MG1645
  - ③ 2x M3X10ISO4762
  - ④ 1x M6X12BN5128
- kg ~1,0

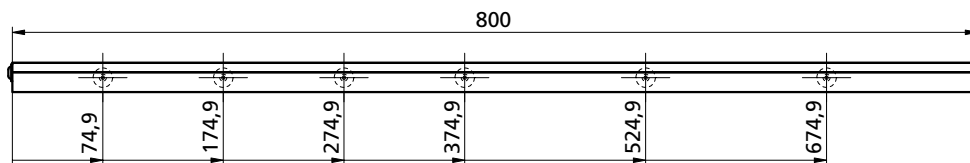

#### PCMAS700ML

- ① 1x PCMAS700ML
  - ② 2x MG1645
  - ③ 2x M3X10ISO4762
  - ④ 1x M6X12BN5128
- kg ~0,88

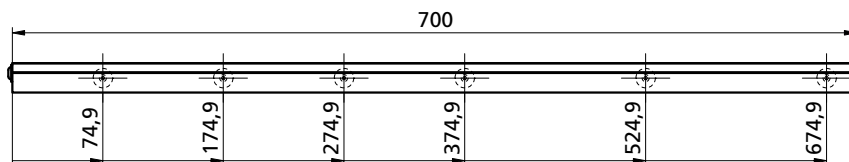

#### PCMAS600ML

- ① 1x PCMAS600ML
  - ② 2x MG1645
  - ③ 2x M3X10ISO4762
  - ④ 1x M6X12BN5128
- kg ~0,75

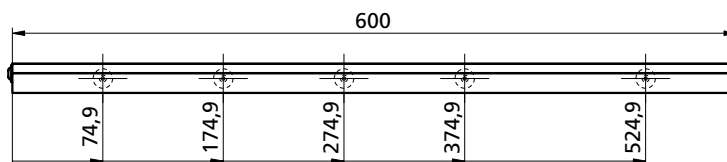

#### PCMAS500ML

- ① 1x PCMAS500ML
  - ② 2x MG1645
  - ③ 2x M3X10ISO4762
  - ④ 1x M6X12BN5128
- kg ~0,63

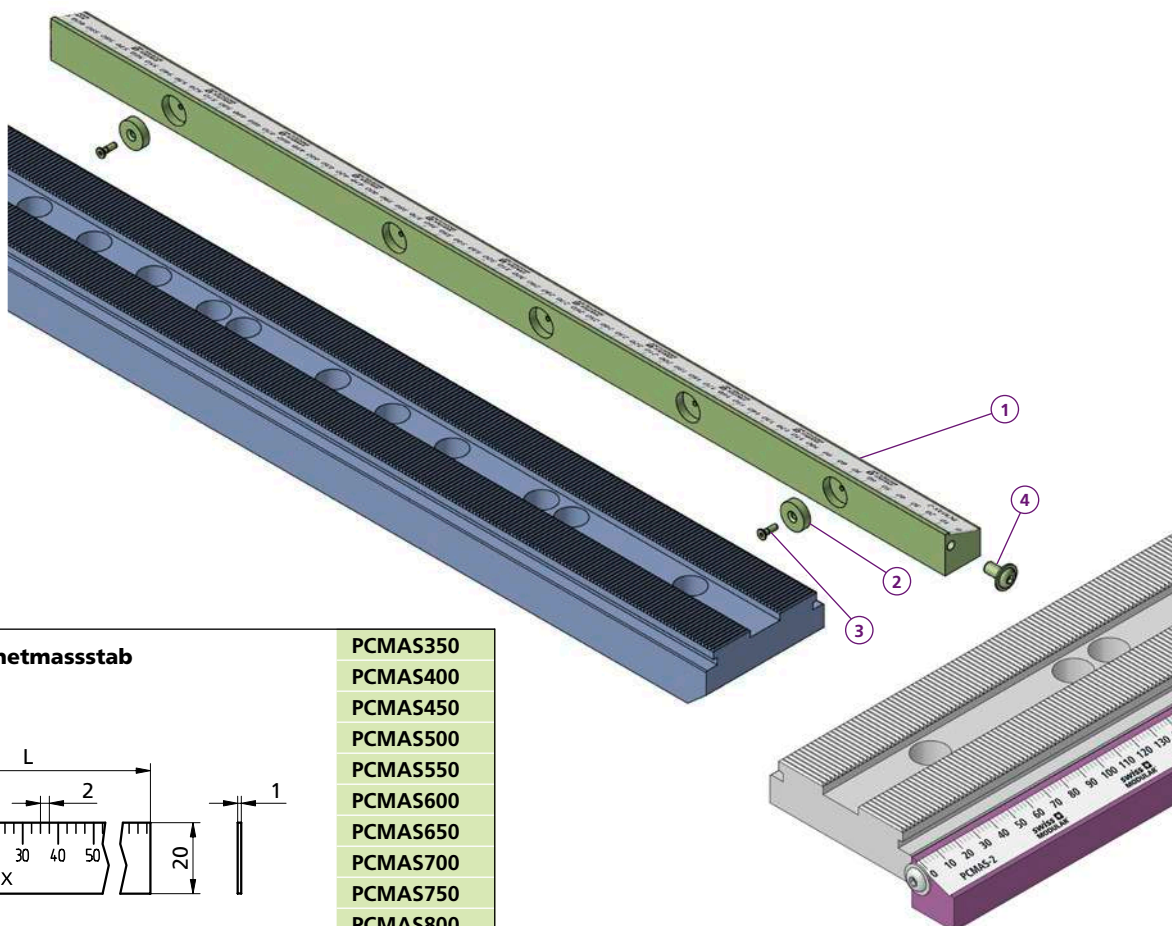
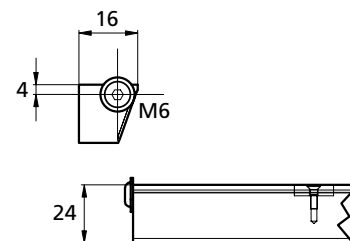
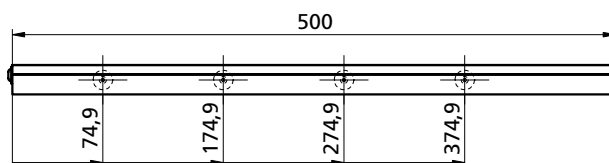

### Alu - Magnetmasstab Alu scale

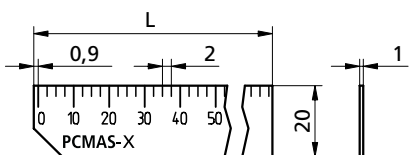

- PCMAS350
- PCMAS400
- PCMAS450
- PCMAS500
- PCMAS550
- PCMAS600
- PCMAS650
- PCMAS700
- PCMAS750
- PCMAS800

Bestellbeispiel / Ordering example : PCMAS800ML

Separat bestellen / Order separately

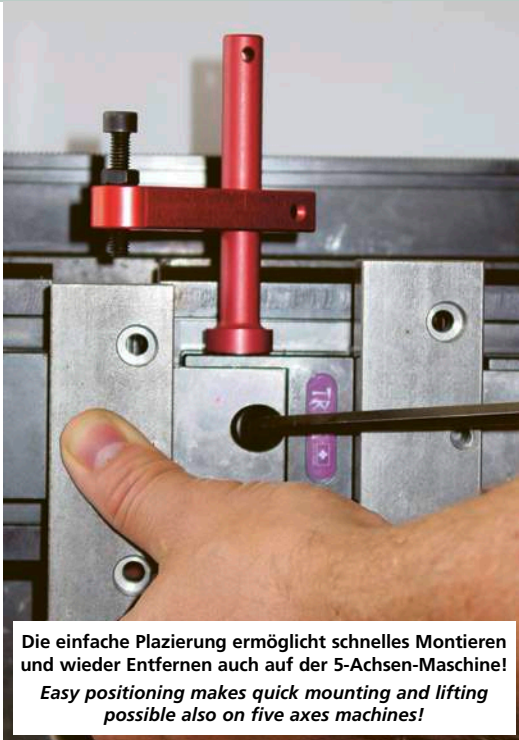

Die einfache Platzierung ermöglicht schnelles Montieren und wieder Entfernen auch auf der 5-Achsen-Maschine!  
Easy positioning makes quick mounting and lifting possible also on five axes machines!

**Die 3 Sicherheitsstufen:**

Durch seine rote Farbe ist der Anschlag besser sichtbar, was das Risiko vermindert, dass er in der Maschine vergessen wird.

Die Bohrung dient zum Befestigen einer Schnur am Handgelenk oder ausserhalb der Maschine.

Dank dem Magnet ist der Anschlag auf allen magnetischen Materialien auf minimalem Platz einsetzbar, bei Kollision wird er weggedrückt. Es entstehen so keine teuren Werkzeugbrüche oder Maschinendefekte.

**The 3 safety levels:**

Because of its red color, the buffer is better visible. So the risk of forgetting the device in the machine is diminished.

The drilling serves to fasten a cord around the wrist or outside the machine.

Its magnet makes the buffer applicable on all magnetic materials on minimum space, in case of collision it gets pressed away, so there won't be any expensive breaking of tools or machines.

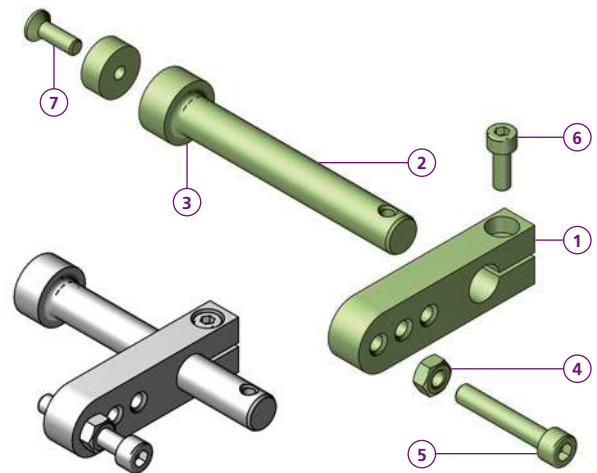
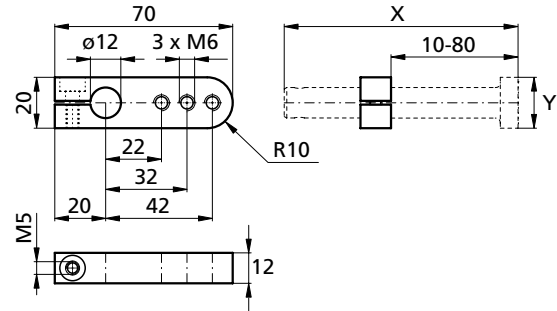

Haltekraft / Holding force	Haltekraft / Holding force
45N = 4,5daN (~4,5 kg)	80N = 8daN (~8 kg)
<b>FAUM2070</b>	<b>FAUM2070S</b>
1 1x FA2070	1 1x FA2070
2 1x FAD2092	2 1x FAD2092S
3 2x MG1645	3 1x MG2570
4 2x M6ISO4032	4 1x M6ISO4032
5 1x M6X35ISO4762	5 1x M6X35ISO4762
6 1x M5X14ISO4762	6 1x M5X14ISO4762
7 1x M3X8ISO10642	7 1x M5X16ISO10642
X = 92	X = 95
Y = ø 20	Y = ø 25
kg ~0,084	kg ~0,1

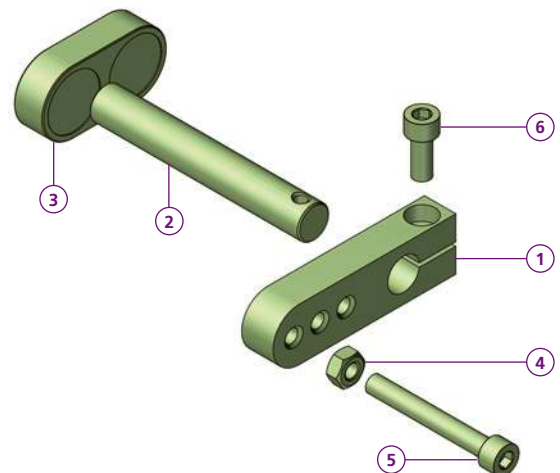
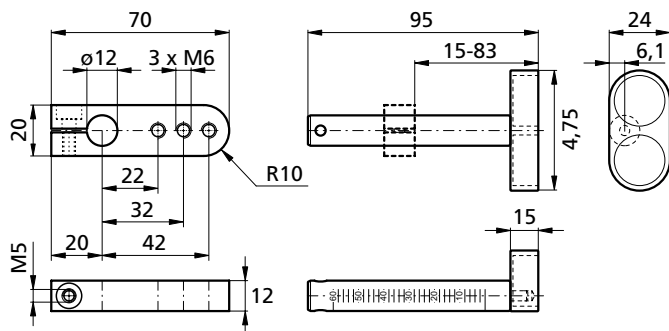

Haltekraft / Holding force
120N = 12daN (~12 kg)
<b>FAUM2070US</b>
1 1x FA2070
2 1x FAD1280
3 1x FUSSUS
4 1x M6ISO4032
5 1x M6X35ISO4762
6 1x M5X14ISO4762
kg ~0,146

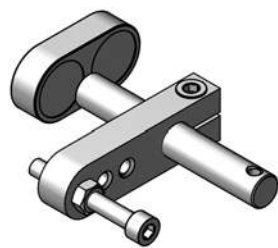

Bestellbeispiel Ordering example : FAUM2070US

**Fräsanschlag / Milling buffer**

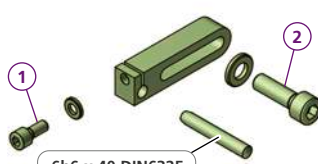
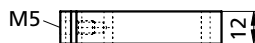
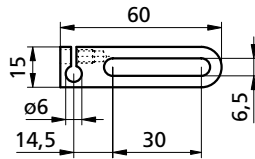
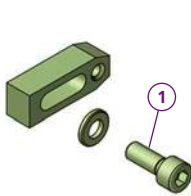
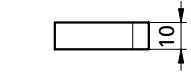
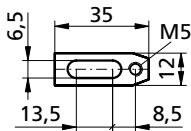

6h6 x 40 DIN6325

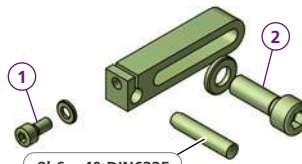
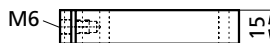
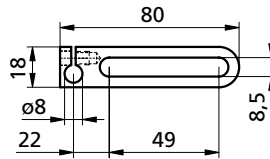

8h6 x 40 DIN6325

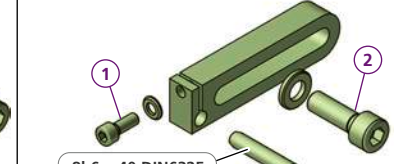
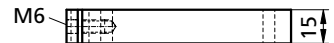
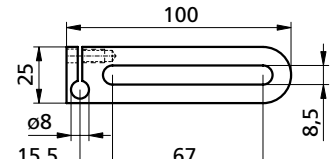

8h6 x 40 DIN6325

**FA1240**  
 1x M6X18ISO4762  
 1x M5X12ISO4762  
 kg ~0,024

**FA1260**  
 1x M6X20ISO4762  
 1x M5X12ISO4762  
 kg ~0,07

**FA1280**  
 1x M6X12ISO4762  
 1x M8X25ISO4762  
 kg ~0,014

**FA12100**  
 1x M6X16ISO4762  
 1x M8X25ISO4762  
 kg ~0,022

**Distanzbüchse zu Fräsanschlag  
 Spacers for workpiece stop**

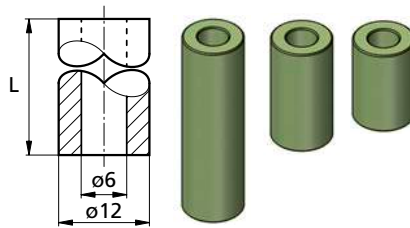
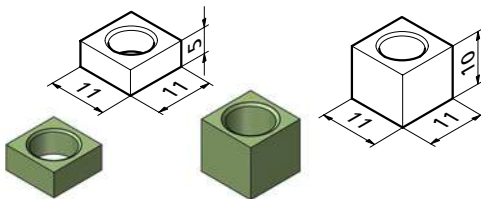

FAD	L	kg
FAD12018	18	~0,012
FAD12023	23	~0,016
FAD12040	40	~0,026

CCD005

CCD010

FAD12018  
 FAD12023  
 FAD12040

**Positionierstift (spreizbar)  
 Locating pin (expandable)**

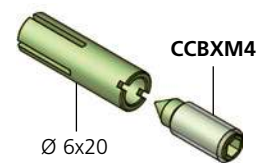

CCBX0802

**Druckstift / Gripping pins**

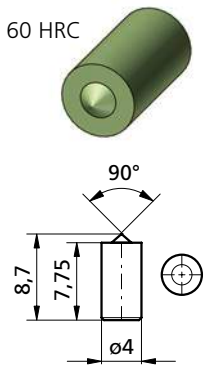

DS0402-90°

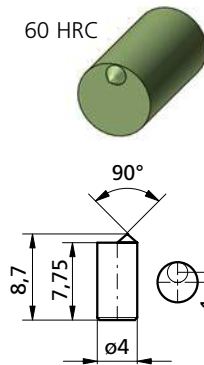

DSE0402-60°

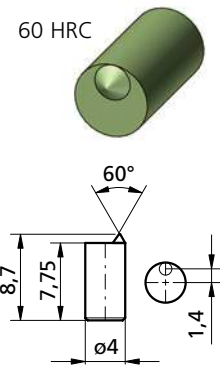

DSE0402-90°

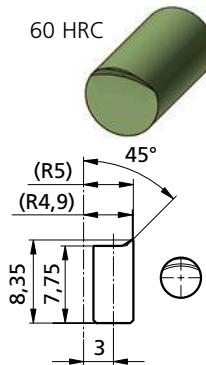

DSE0402-BS

**Einbauanleitung  
 Installation guide**  
 Bohrung vorbereiten  
 Preparation of drill-hole  
 Einkleben mit / Glue with  
 Loctite 641

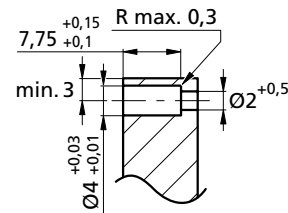

**Hartmetalldruckstück  
 Carbide gripper**

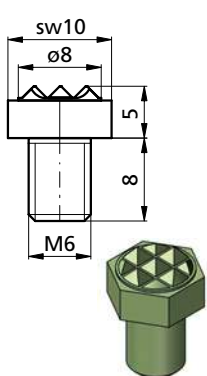

CCHMR

**Prägespannschraube  
 Stamping roll screw**

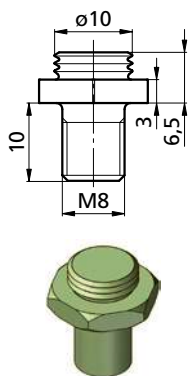

PRG1003M8

**Bohrbild  
 Hole pattern**

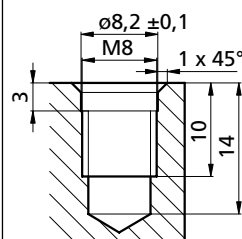

**Kugeldruckstück  
 Gripper**

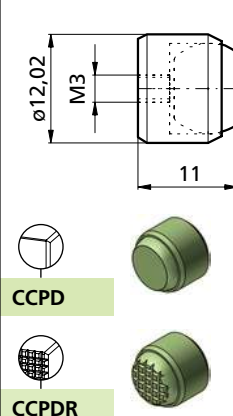

CCPDR

**Ausrichtzapfen für T-Nuten  
 Alignment-pins for t-slots**

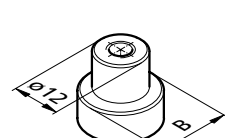

TWADAPT	B
TWADAPT10	10
TWADAPT12	12
TWADAPT14	14
TWADAPT16	16
TWADAPT18	18
TWADAPT20	20
TWADAPT22	22



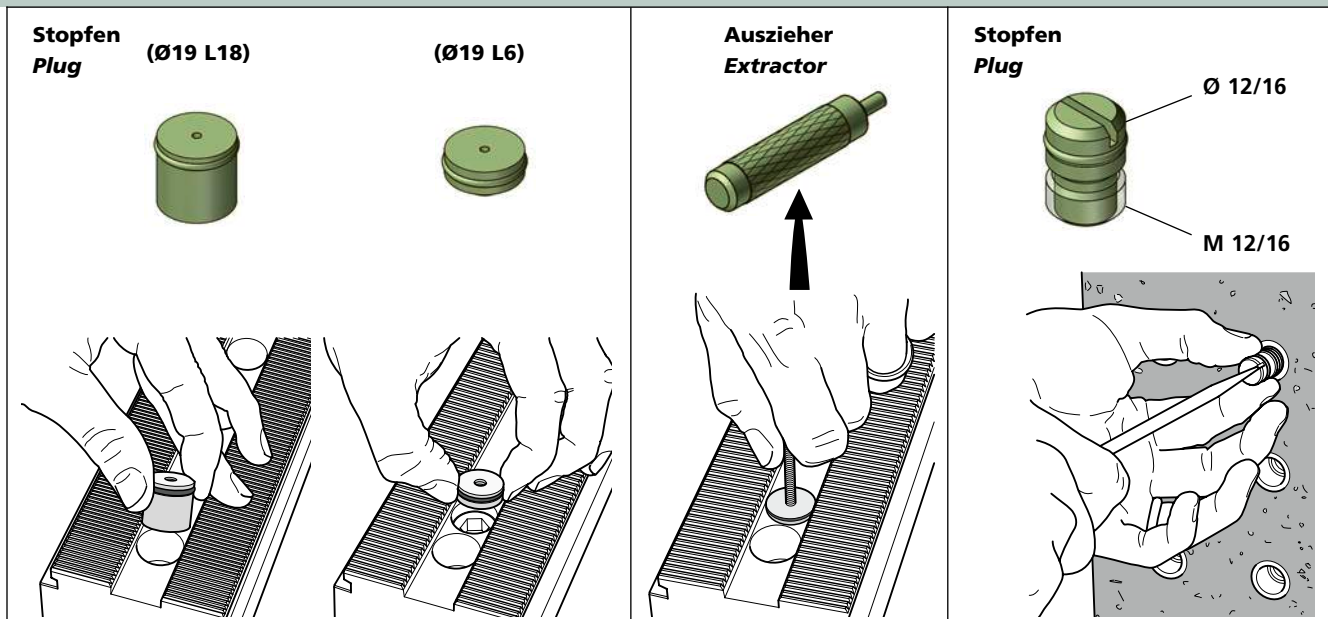

PCPF16L18      PCPF16L6      PCAZM3      CCPF12ALU / CCPF16ALU

**Spannschrauben (Nitriert)**  
**Clamping screw (Nitrided)**

für/for kg

M8x20ISO4762NQ	B60	~0,012
M10x25ISO4762NQ	B80	~0,024

**Passschrauben / Fitting screw**

M5 / M6 / M12 / M16

**Reduktionshülsen für Rasterplatte**  
**Reduction sleeve for grid plate**

RD18M1612M12      RD16M1612M12      RD16M12

	D	G	L	B	K	sw	Nm	kg
MS50	5 f7	M5	17	9	5	4	4,5	~0,004
MS60	6 f7	M6	17	9	6	5	8	~0,006
TWPAS1227	12 g7	M12	27	14	12	10	60	~0,038
TWPAS1232	12 g7	M12	32	19	12	10	60	~0,042
TWPAS1240	12 g7	M12	40	20	12	10	60	~0,048
TWPAS1250	12 g7	M12	50	30	12	10	60	~0,058
TWPAS16055	16 f7	M16	55	30	15,8	14	150	~0,120

**T-Nuten Steine / T-slot nuts**

d	α	kg
SM1135 M06X08	~0,012	
SM1135 M06X10	~0,012	
SM1135 M08X10	~0,012	
SM1135 M08X12	~0,022	
SM1135 M08X14	~0,04	
SM1135 M10X12	~0,02	
SM1135 M10X14	~0,038	
SM1135 M12X14	~0,045	
SM1135 M12X16	~0,045	
SM1135 M12X18	~0,078	
SM1135 M12X20	~0,13	
SM1135 M14X16	~0,188	
SM1135 M14X18	~0,188	
SM1135 M16X18	~0,068	
SM1135 M16X20	~0,11	
SM1135 M18X20	~0,11	
SM1135 M18X22	~0,15	
SM1135 M18X22	~0,15	
SM1135 M20X22	~0,15	
SM1135 M20X24	~0,23	
SM1135 M24X28	~0,31	

**Bohrbüchsen**  
**Position case**

	L	D	d
CCBUE121812	12	18,0	12,0
CCBUE1218512	12	18,5	12,0
CCBUE121912	12	19,0	12,0
CCBUE162616	16	26,0	16,0

**Nutensteine, flach**  
**Low slot tenons**

Einsatzgehärtet, brüniert, geschliffen  
Case-hardened, blackened, ground

	b	H	L	d1	d2	t	inkl. Schrauben incl. screws	kg
SM1136- 12	8	20	5,5	10	5,3		M5x12	~0,019
SM1136- 14							M6x16	~0,021
SM1136- 16							M6x16	~0,026
SM1136- 18	10	22	6,6	11	6,3		M6x16	~0,03
SM1136- 20							M6x16	~0,034

**Nutensteine, fest**  
**Fixed slot tenons**

Einsatzgehärtet, brüniert, geschliffen  
Case-hardened, blackened, ground

	H	L	b	Nutenmass slot size	inkl. Schrauben incl. screws	kg
NT2012	10	25	22	12	20	M6x10 ~0,022
NT2014			14	20	M6x10 ~0,026	
NT2016			16	20	M6x10 ~0,028	
NT2018	12	32	18	20	M6x10 ~0,03	
NT2022			22	20	M6x12 ~0,05	
NT2024			24	20	M6x12 ~0,055	

**Pneumatikschrauber Set**  
**Pneumatic screwdrivers set**

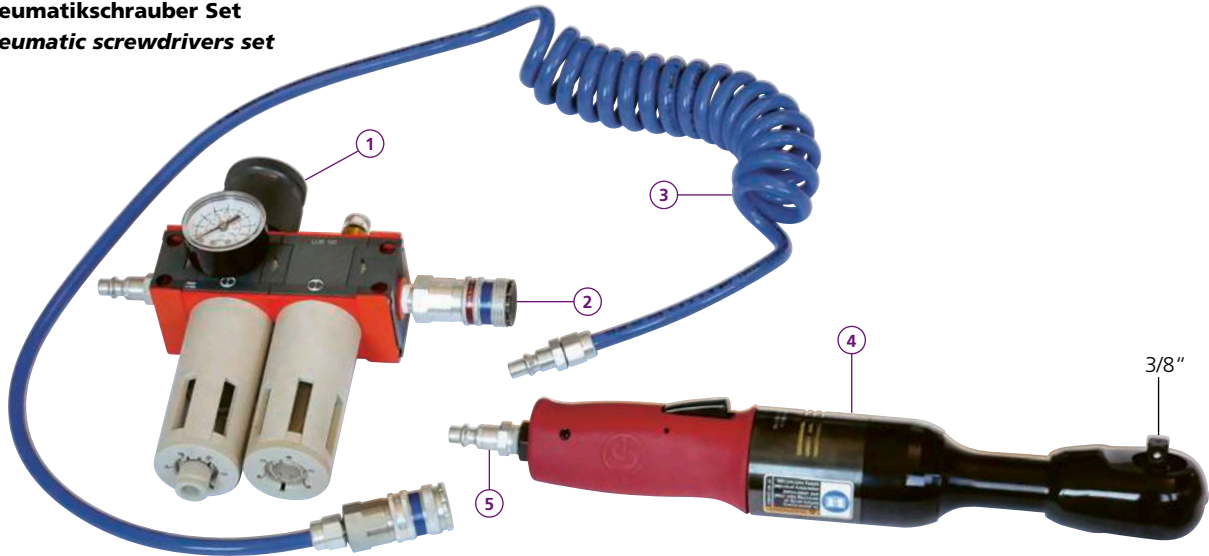

**RP9431SET**

- ① 1x P1H-200-M3QG
  - ② 1x 103002152 (SERIE 300) 1/4"
  - ③ 1x 199589977 (5 x 8 mm, 300, 2 m)
  - ④ 1x RP9431
  - ⑤ 2x 103105152 1/4"
- kg ~1,5

Drehmomenttabelle / Torque table	Druck / Compression (bar)	Nm
	6	50
Schlauchdurchmesser 8 mm	5,5	45
Luftverbrauch 2,5 L Sek	5	40
	4,5	35
Hose diameters 8 mm	4	30
Air consumption 2,5 L sec	3,5	25
	3	20

mit Feder gehalten, nicht magnetisch  
 spring locked, not magnetic



mit Feder gehalten, nicht magnetisch  
 spring locked, not magnetic



siehe Video  
 see video

**Triag Bit**

**Triag Bitburr**

**Luftpistolen Gummiadapter**  
**Air gun rubber adapter**

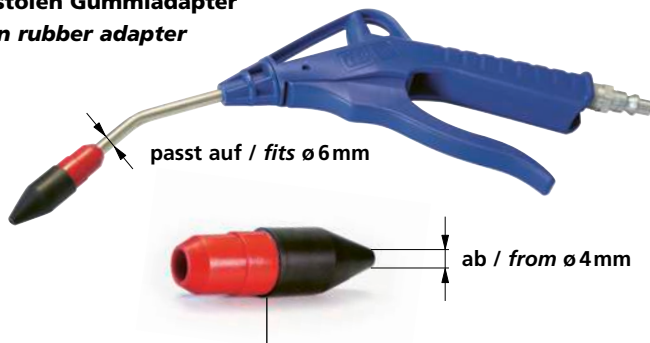

**Einsätze zu Bitburr**  
**Inserts for Bitburr**



TC10

BitF63 Ø 6,3-90°



BIT-KH

BitF104 Ø 10,4-90°



BIT-BF

BitF165 Ø 16,5-90°

**ARA14**

**Magnethalter**  
**Magnetic holder**

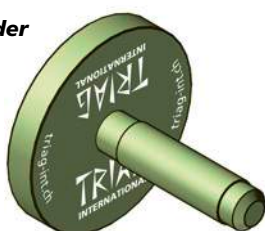

**Einsatz für Triva Bit**  
**Insert for Triva Bit**



**Smiley**

**BitT**

Bestellbeispiel / Ordering example: **RP9431SET**

**Drehmomentschlüssel**  
*Torque wrench*





**SL3** 20-200 Nm (1/2")

**Steckschlüsseleinsatz**  
*Socket wrench insert*

Torx  Sechskanteinsatz *Hexagon insert* 

NUSS3/8"TX30E14	für / for	MCZ, ZSX, ZSM, ZSB, PCZ
NUSS1/4"4.5MM	4,5 mm	für / for MCZ40L30,
NUSS1/4"5.5MM	5,5 mm	UB5AXSET3, PCZ80L40PRG62

**Sechskantstifteinsatz**  
*Hexagonal socket wrench*

(L) lang  (LK) lang mit Kugelkopf   
(L) long (LK) long with ball head

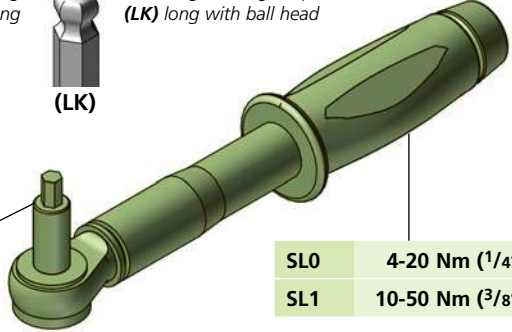

**SL0** 4-20 Nm (1/4")  
**SL1** 10-50 Nm (3/8")

NUSS1/4"4MM	4 mm	NUSS3/8"6MM	
NUSS1/4"5MM	5 mm	NUSS3/8"6MML	6 mm
NUSS1/4"6MM	6 mm	NUSS3/8"6MMLK	
NUSS1/4"8MM	8 mm	NUSS3/8"8MM	
		NUSS3/8"8MML	8 mm
		NUSS3/8"8MMLK	
NUSS3/8"5MM		NUSS3/8"10MM	
NUSS3/8"5MML	5 mm	NUSS3/8"10MML	10 mm
NUSS3/8"5MMLK		NUSS3/8"10MMLK	

**Spannschlüssel**  
*Clamping wrench*



02613160	4 mm
02613164	5 mm
02613168	6 mm
02613172	8 mm
02613176	10 mm

**Langer Spannschlüssel**  
*Long clamping wrench*

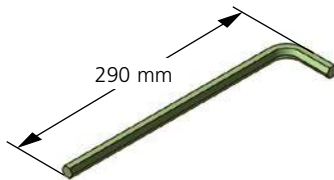

290 mm

ISL10	sw = 10 mm
ISL14	sw = 14 mm

**Sechskantstifteinsatz**  
*Hexagonal socket wrench*



NUSS1/2"8MM	NUSS1/2"14MML
NUSS1/2"10MM	
NUSS1/2"14MM	



AD-BIT-1/4-1/4



AD-BIT-1/4-3/8

**Messingdrahtbürste**  
*Brass wire brush*

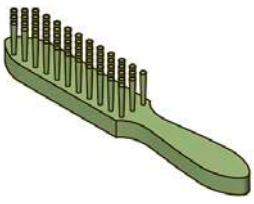

**PCMB4**



**Triag Ei**

**3D Mess-Gelenkstativ**  
*Articulated indicator holders*



Aktionsradius / Operating radius

MGMS08130	130 mm
MGSS08130	130 mm
MGMS08280	280 mm