

**Drehmomentschlüssel**  
*Torque wrench*





**SL3** 20-200 Nm (1/2")

**Steckschlüsseleinsatz**  
*Socket wrench insert*

Torx  Sechskanteinsatz *Hexagon insert* 

NUSS3/8"TX30E14	für / for	MCZ, ZSX, ZSM, ZSB, PCZ
NUSS1/4"4.5MM	4,5 mm	für / for MCZ40L30,
NUSS1/4"5.5MM	5,5 mm	UB5AXSET3, PCZ80L40PRG62

**Sechskantstifteinsatz**  
*Hexagonal socket wrench*

(L) lang  (LK) lang mit Kugelkopf   
(L) long (LK) long with ball head

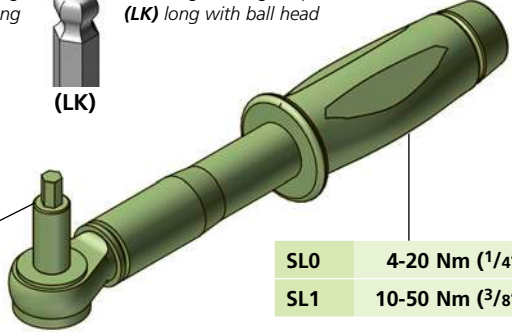

**SL0** 4-20 Nm (1/4")  
**SL1** 10-50 Nm (3/8")

NUSS1/4"4MM	4 mm	NUSS3/8"6MM	
NUSS1/4"5MM	5 mm	NUSS3/8"6MML	6 mm
NUSS1/4"6MM	6 mm	NUSS3/8"6MMLK	
NUSS1/4"8MM	8 mm	NUSS3/8"8MM	
		NUSS3/8"8MML	8 mm
		NUSS3/8"8MMLK	
NUSS3/8"5MM		NUSS3/8"10MM	
NUSS3/8"5MML	5 mm	NUSS3/8"10MML	10 mm
NUSS3/8"5MMLK		NUSS3/8"10MMLK	

**Spannschlüssel**  
*Clamping wrench*



02613160	4 mm
02613164	5 mm
02613168	6 mm
02613172	8 mm
02613176	10 mm

**Langer Spannschlüssel**  
*Long clamping wrench*

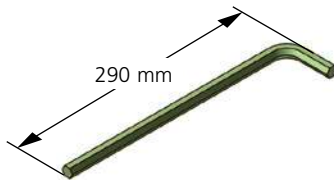

290 mm

ISL10	sw = 10 mm
ISL14	sw = 14 mm

**Sechskantstifteinsatz**  
*Hexagonal socket wrench*



NUSS1/2"8MM	NUSS1/2"14MML
NUSS1/2"10MM	
NUSS1/2"14MM	



AD-BIT-1/4-1/4



AD-BIT-1/4-3/8

**Messingdrahtbürste**  
*Brass wire brush*

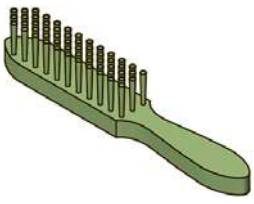

**PCMB4**



**Triag Ei**

**3D Mess-Gelenkstativ**  
*Articulated indicator holders*



Aktionsradius / Operating radius

MGMS08130	130 mm
MGSS08130	130 mm
MGMS08280	280 mm