

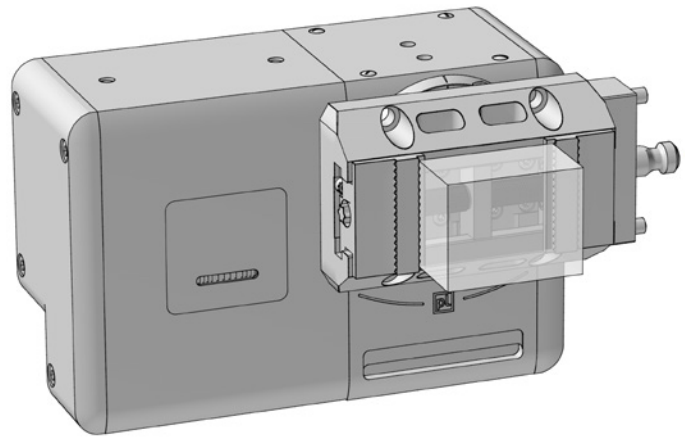

Maschinenspezifische Spannlösungen  
*Machine specific workholding solutions*

**swiss**   
**MODULAR**<sup>®</sup>

by Triag International AG



## **powerCLAMP**

Hochflexibel, zuverlässig  
und einfach zu bedienen.

*High flexibility, reliable  
and easy to handle.*



 **LEHMANN**<sup>®</sup>

**EA-510 L**

**EA-507 L**

**T1-520530.LL**



# triCENTRO

pl LEHMANN: Zentrischspanner «ZSX» inkl. Adapterflansch  
 pl LEHMANN: Self centering vise «ZSX» incl. adapter flange



Höchste Modularität  
 Highest modularity

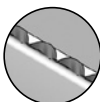

3mm Direkt-Prägebacken  
 3mm Direct stamping jaws



Spannkrafterhaltung mit Nachfederung  
 Spring loaded mechanism to maintain clamping force



(Erowa) Greifer / Gripper  
 Zur Automatisierung mit RCS5 Kupplung  
 For automation with RCS5 clutch

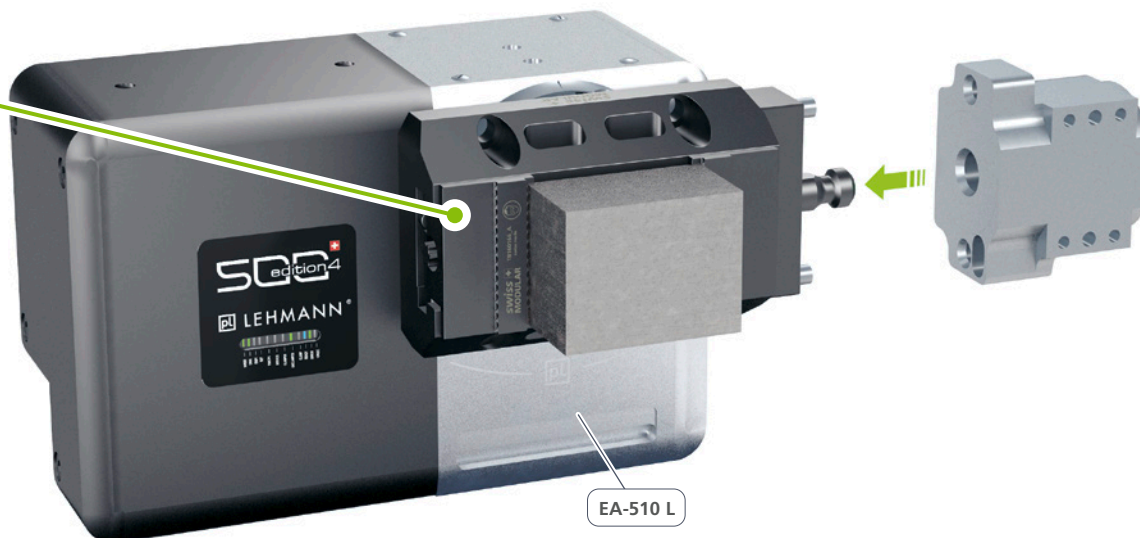

Bestellschlüssel Order code	Bezeichnung Description	~ Kg	Teilapparat NC Rotary table	Spannbereich A Clamping area A	Spannbereich B Clamping area B
<b>ZSX180PL-RCS5-SET</b>	Maschinenset / Machine set	6,5	<b>EA 510 L</b>	<b>10 – 104</b>	<b>64 – 158</b>
	Maschinenset / Machine set		<b>EA 507 L</b>		
	Maschinenset / Machine set		<b>T1-520530.LL</b>		

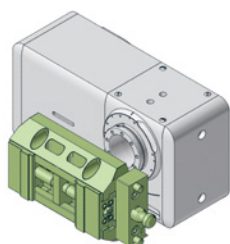

**ZSX180PL-RCS5-SET**





**pl LEHMANN®**

**PL T1-520530.LL**

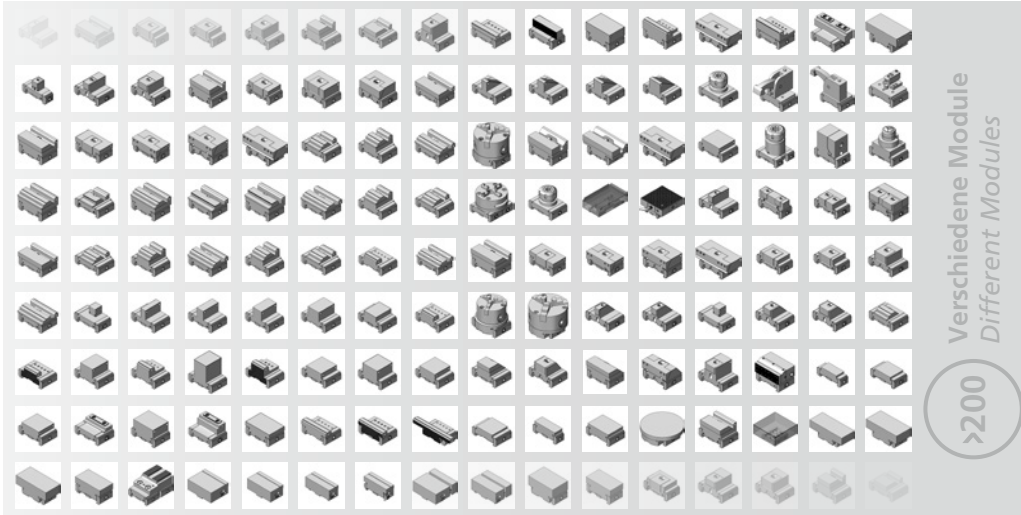
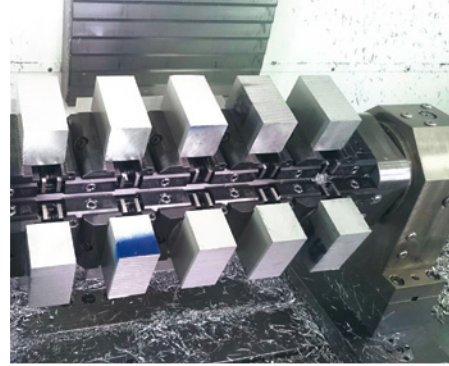

Verschiedene Module  
Different Modules

>200

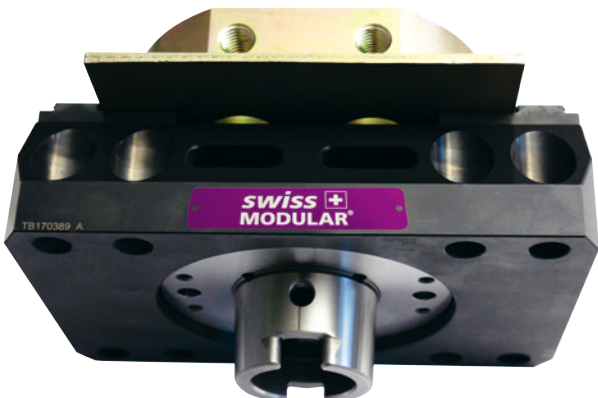
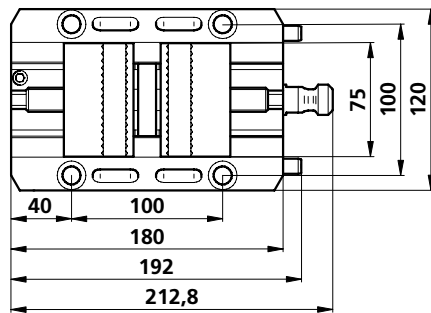
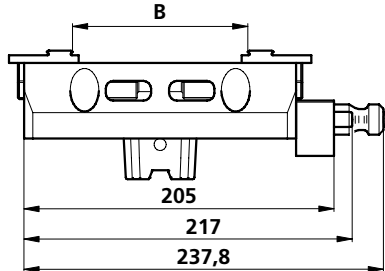
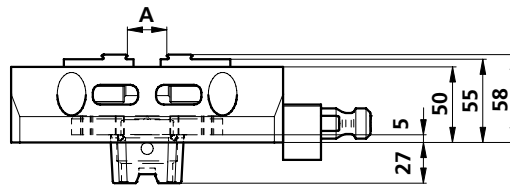
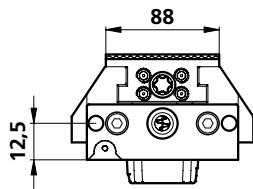
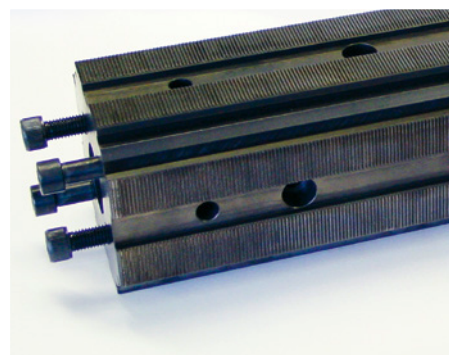
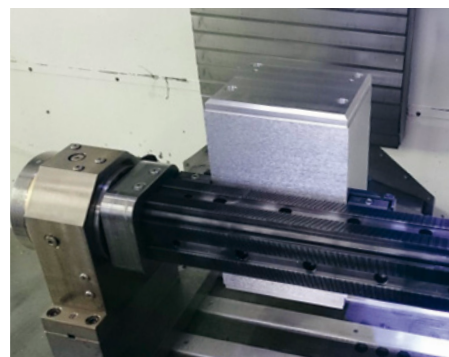
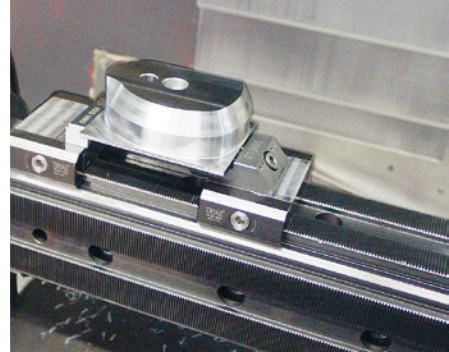

## powerCLAMP

Ein einfaches universelles System für verschiedene Anwendungen.

*One simple universal system for different applications.*

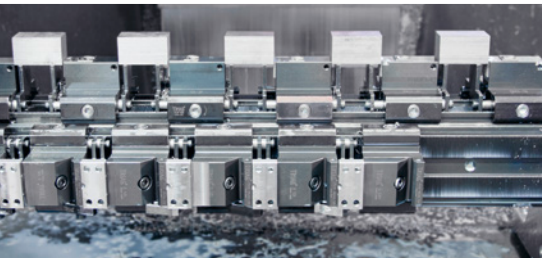
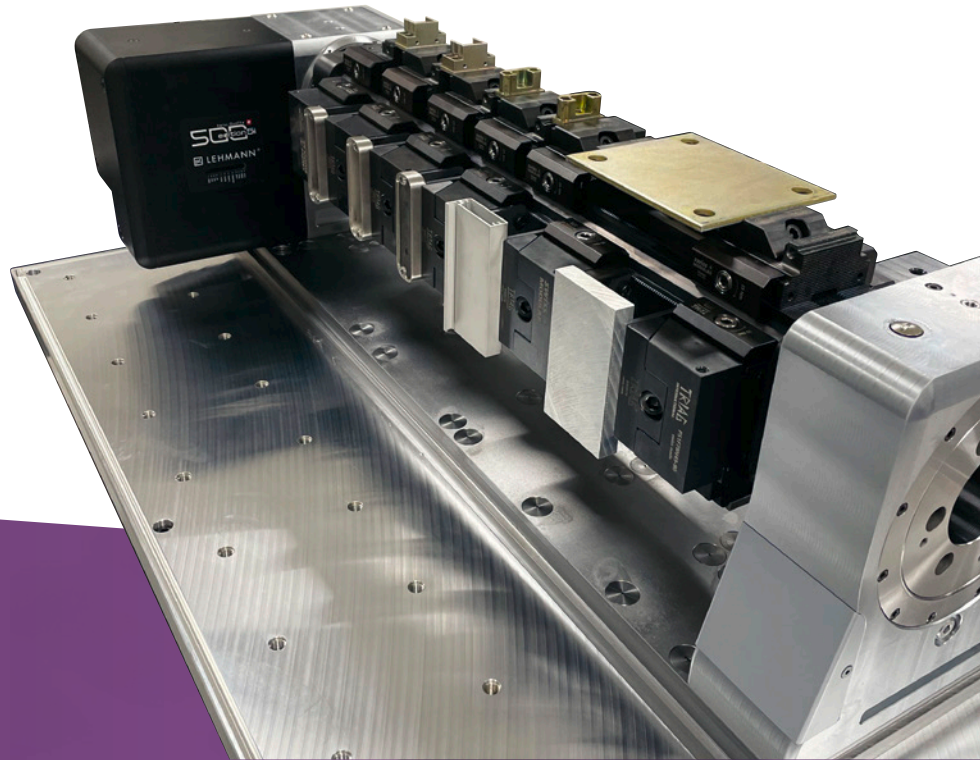

### Triag International AG

Bösch 84 CH-6331 Hünenberg

☎ +41 41 727 27 77

✉ [spannen@triag-int.ch](mailto:spannen@triag-int.ch)

✉ [clamping@triag-int.ch](mailto:clamping@triag-int.ch)

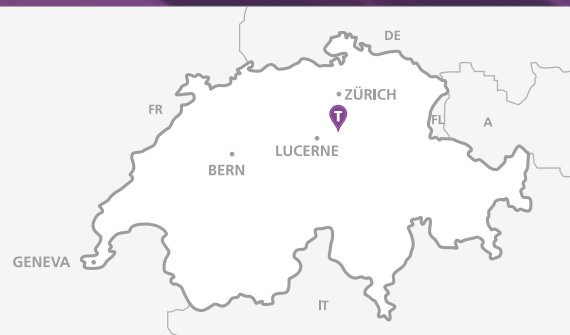

Unser Vertriebspartner in Ihrer Nähe:

*Our reseller in your area:*





