

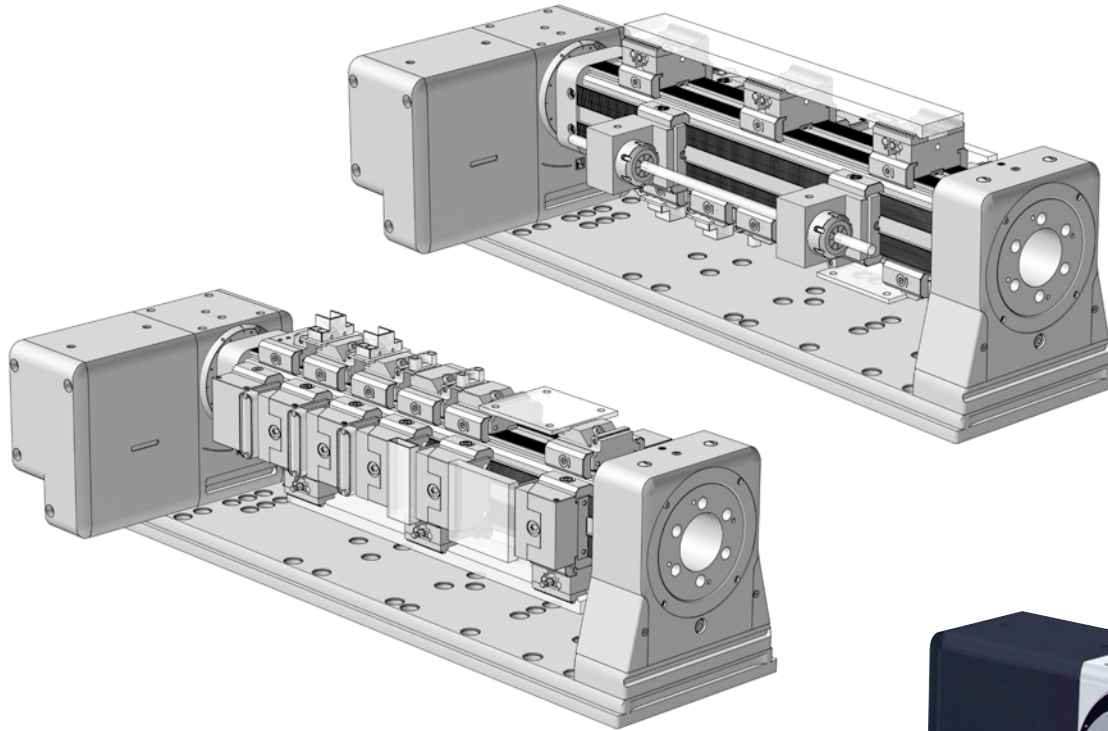

Maschinenspezifische Spannlösungen
Machine specific workholding solutions

swiss 
MODULAR[®]

by Triag International AG



powerCLAMP

Hochflexibel, zuverlässig
und einfach zu bedienen.

*High flexibility, reliable
and easy to handle.*



 **LEHMANN**[®]

PL 510

powerCLAMP



pl LEHMANN: Modulares Mehrfachspannsystem mit powerCLAMP und PCT Monoblock

pl LEHMANN: Modular multiple workholding system with powerCLAMP and PCT monobloc



powerCLAMP Schnittstelle
powerCLAMP interface



3mm Direkt-Prägebacken
3mm Direct stamping jaws



Verschiedene Anschlagmodule
Different stop modules

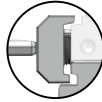







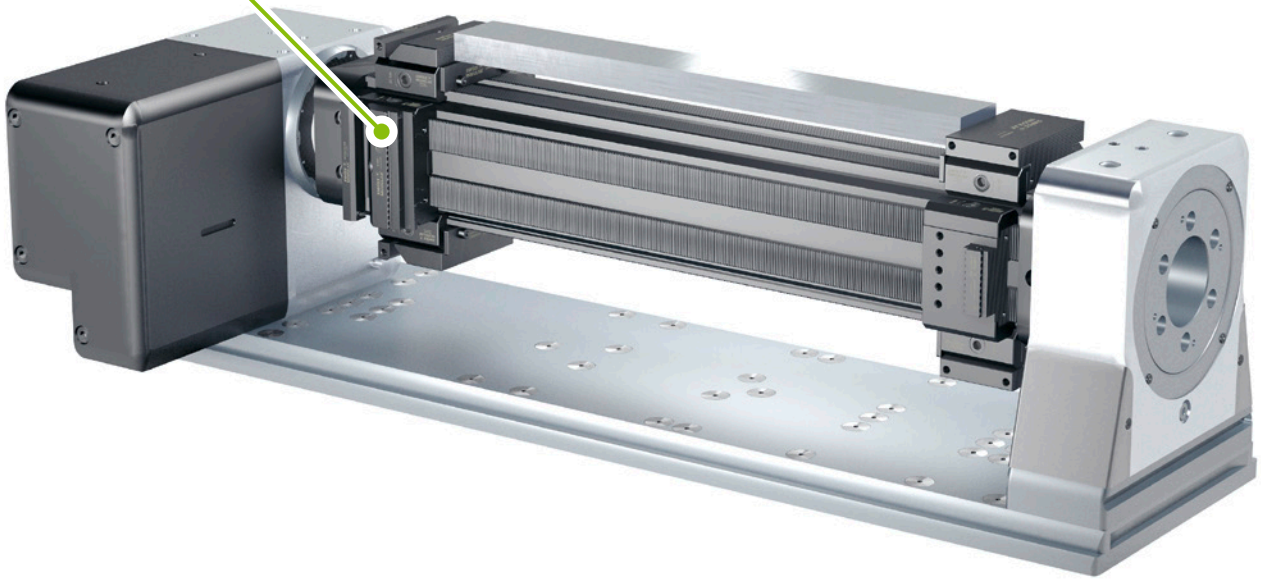

powerCLAMP Pratzensystem
powerCLAMP side clamp system



Höchste Modularität
Highest modularity



Bestellschlüssel Order code	Bezeichnung Description	~ Kg	L1	L2 (OP10)	L3 (OP20)	L4
 PCPL510-300	Maschinenset / Machine set	39	300	232	177,5	593
 PCPL510-350	Maschinenset / Machine set	44	350	282	227,5	643
 PCPL510-400	Maschinenset / Machine set	48	400	332	277,5	693
 PCPL510-450	Maschinenset / Machine set	53	450	382	327,5	743
 PCPL510-500	Maschinenset / Machine set	57	500	432	377,5	793
 PCPL510-550	Maschinenset / Machine set	62	550	482	427,5	843
 PCPL510-600	Maschinenset / Machine set	66	600	532	477,5	893
 PCPL510-650	Maschinenset / Machine set	71	650	582	527,5	943
 PCPL510-700	Maschinenset / Machine set	75	700	632	577,5	993

PCPL510-300



PCPL510-350



PCPL510-400

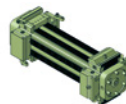

PCPL510-450

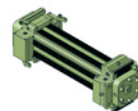

PCPL510-500



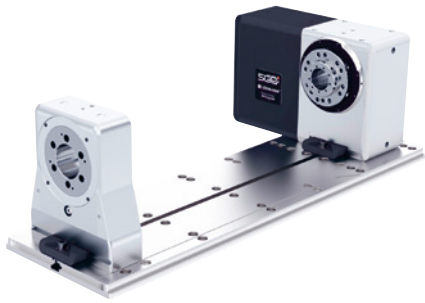

pl LEHMANN®

PL 510

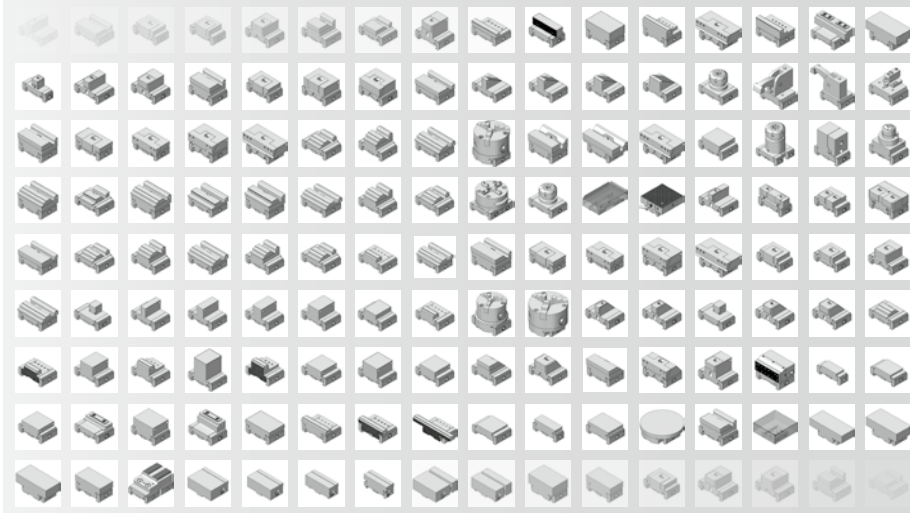
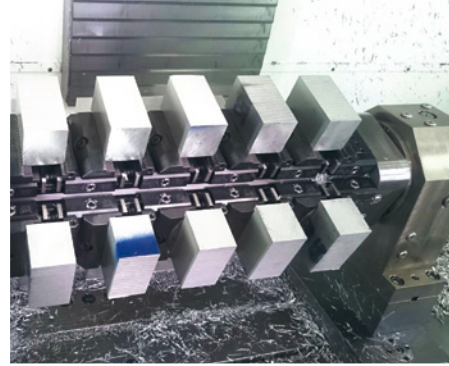

Verschiedene Module
Different Modules

>200

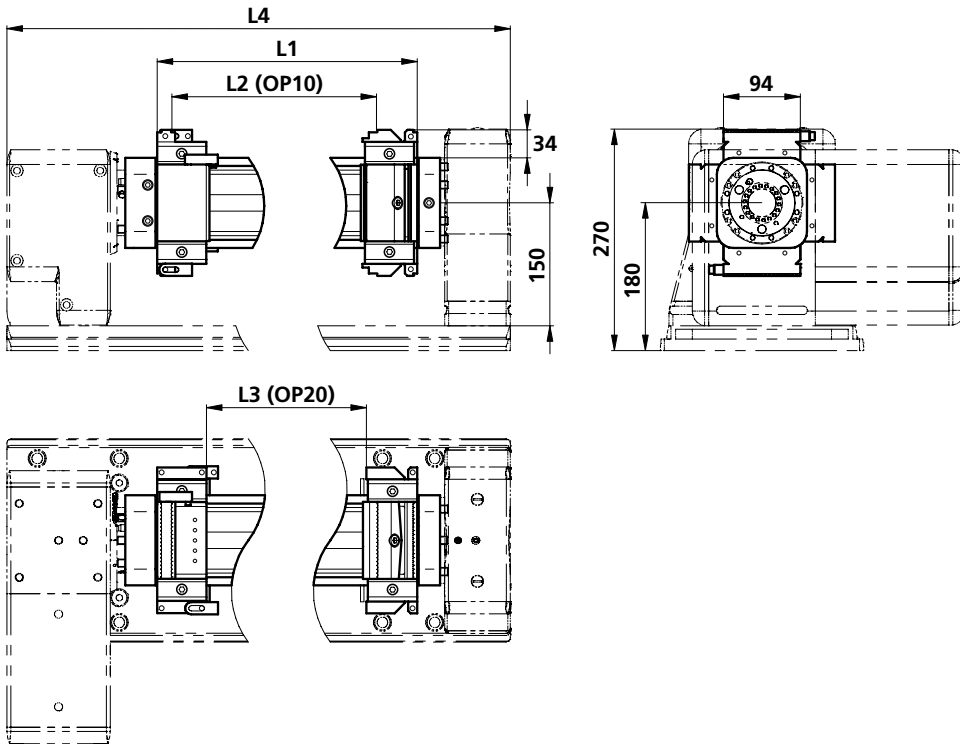
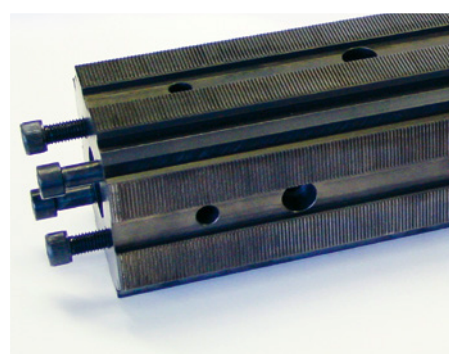
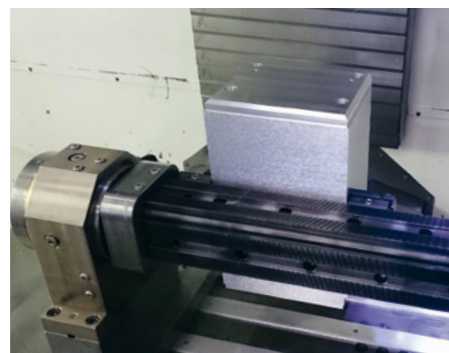
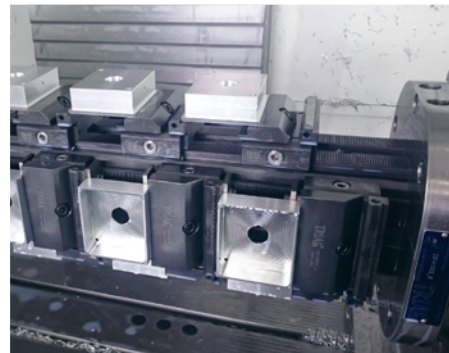
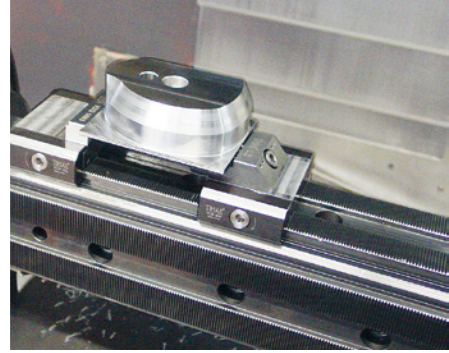

PCPL510-550

PCPL510-600

PCPL510-650

PCPL510-700

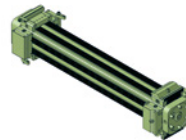
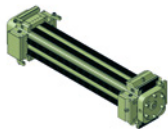

powerCLAMP

Ein einfaches universelles System für verschiedene Anwendungen.

One simple universal system for different applications.

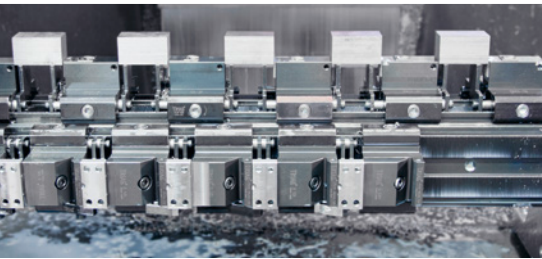
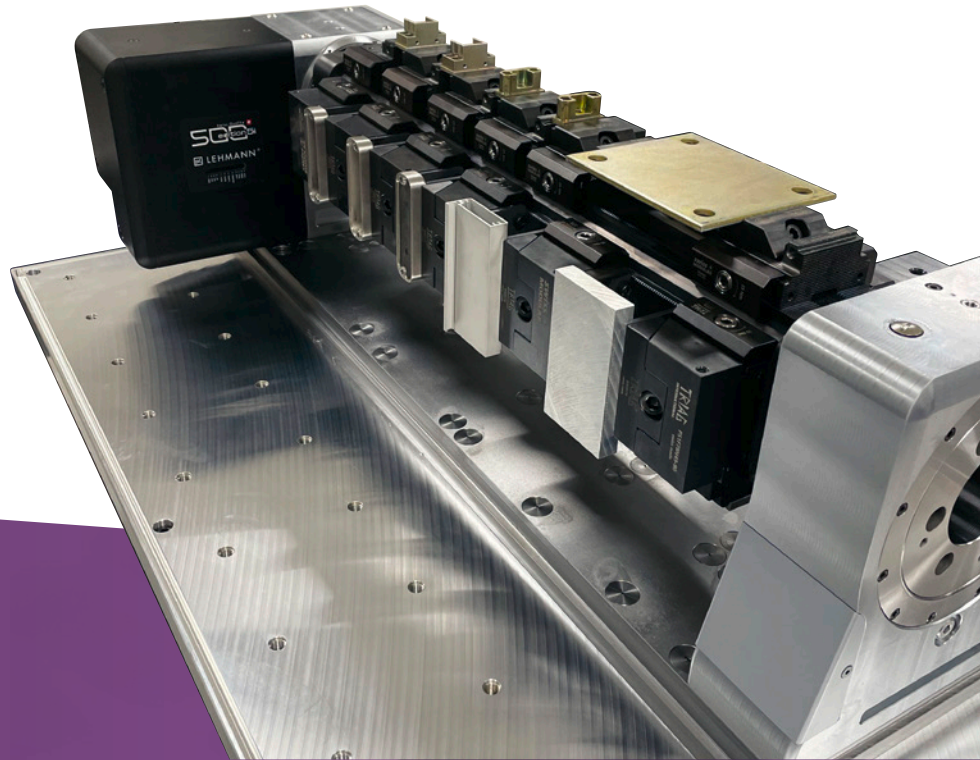

Triag International AG

Bösch 84 CH-6331 Hünenberg

☎ +41 41 727 27 77

✉ spannen@triag-int.ch

✉ clamping@triag-int.ch



Unser Vertriebspartner in Ihrer Nähe:

Our reseller in your area:





